

RECOMMENDED FFC/FPC DIMENSION
FPC THICKNESS=0.30±0.03

SPECIFICATIONS

Current Rating: 0.5A AC,DC
Voltage Rating: 50V AC,DC
Temperature Range: -25°C ~ +85°C
Contact Resistance: 30mΩ Max.
Insulation Resistance: 500MΩ Min.
Withstanding Voltage: 500V AC/minute
Pin Material: Phosphor Bronze/Gold-flash
Solder Tabs: Brass/Matte Tin-plated
House: LCP,UL94V-0
Cover: LCP,UL94V-0,Black

P/N LEGEND

F0517 WRC-S-XP N L N G1 T 00 L
① ② ③ ④ ⑤ ⑥ ⑦ ⑧ ⑨ ⑩ ⑪

① Series No.
② Connector type: WRC=Right angle Type C
③ Mounting type: S=SMT
④ No. of circuits
⑤ N=Halogen Free
⑥ Material: L=LCP
⑦ Color:N=Natural(Beige)
⑧ Plating code for contacts: G1=Gold-flash
⑨ Plating code for solder tabs:
T=Matte Tin-plated
⑩ Option code: 00=Standard
⑪ Packing code: L=Tape & Reel(With Mylar)

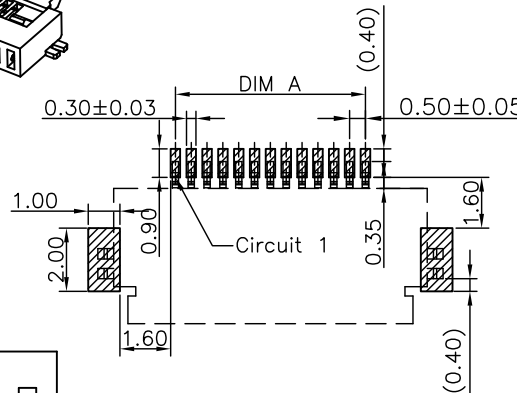
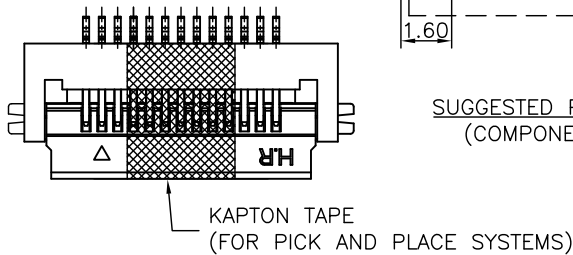
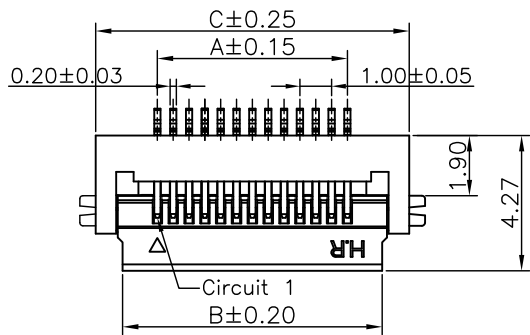

SUGGESTED PCB LAYOUT
(COMPONENT SIDE)

Circuit No.	Dimensions		
	A	B	C
57P	28.00	30.20	31.90
56P	27.50	29.70	31.40
53P	26.00	28.20	29.90
51P	25.00	27.20	28.90
50P	24.50	26.70	28.40
49P	24.00	26.20	27.90
48P	23.50	25.70	27.40
30P	14.50	16.70	18.40
27P	13.00	15.20	16.90
17P	8.00	10.20	11.90
16P	7.50	9.70	11.40
13P	6.00	8.20	9.90
12P	5.50	7.70	9.40
10P	4.50	6.70	8.40
9P	4.00	6.20	7.90
8P	3.50	5.70	7.40
6P	2.50	4.70	6.40

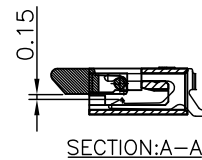
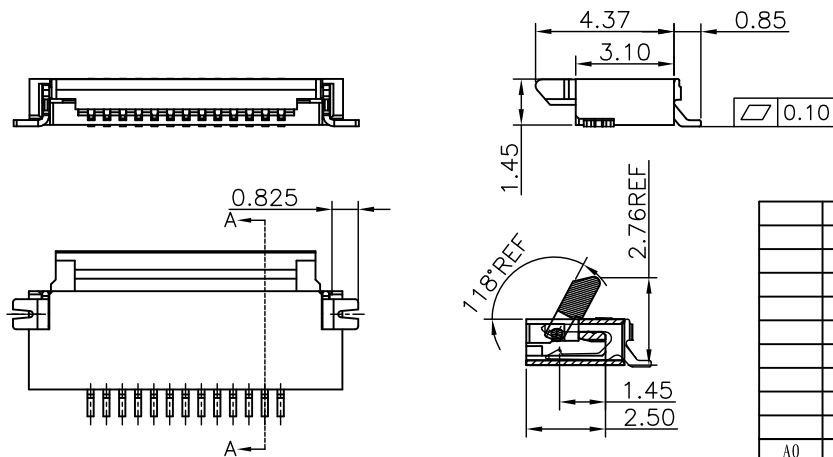

				UNIT	SCALE	SHEET	TITLE:
				mm	1 : 1	1 of 2	
DRAWN BY		APPROVED BY		0.50mm PITCH FFC/FPC CONNECTOR, 90° SMT TYPE,			
李志深		陳彥兆					
2015.02.05		2015.02.05		DRAW NO. : F0517WRC-S-XPXXXXXXX			
GENERAL TOLERANCE				ANGLE±			
X. X±0.25		X. XX±0.15					
X. XXX±0.05		X. XXX±0.05					
A0	NEW RELEASE	2015.02.05	李志深	REV. A0			
REV.	DESCRIPTION	DATE	NAME				

008-020conacts

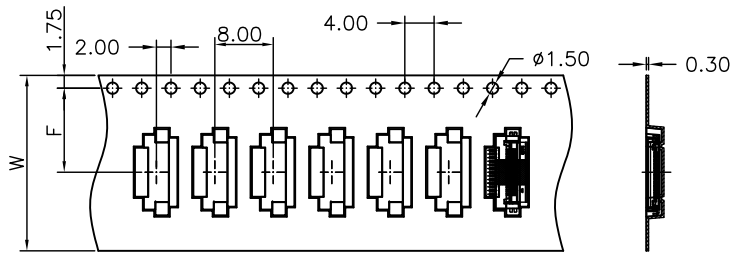

021-057conacts

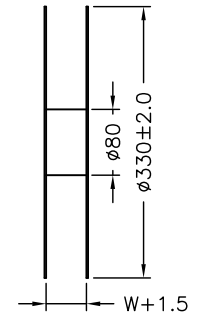
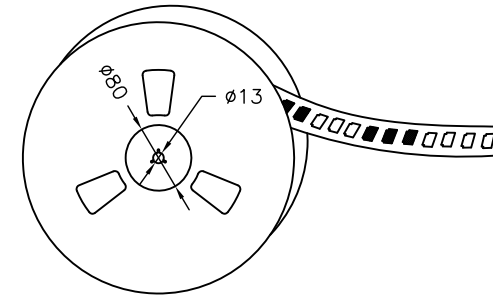
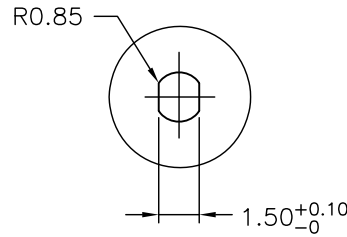
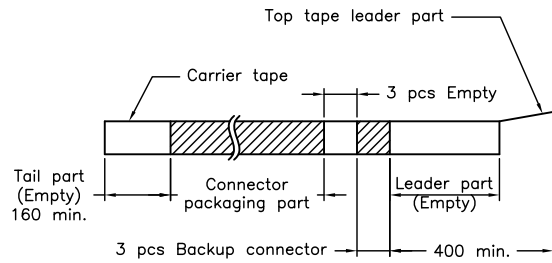
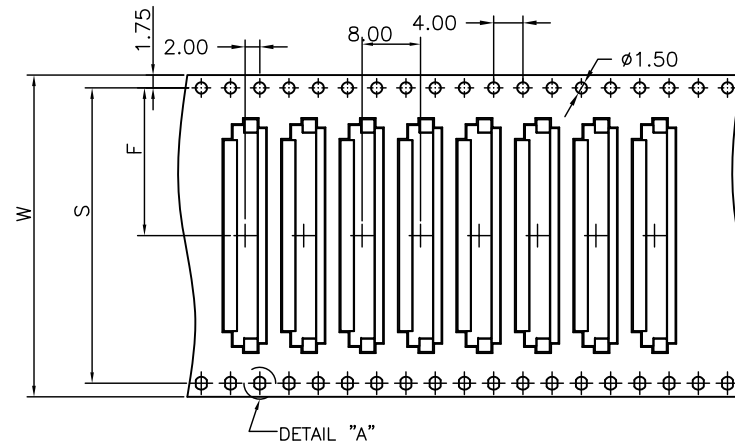

NOTE:
Material:BLAK
Anti-static Polystyrene.

Number of Contacts	W±0.3	F±0.1	S±0.1	Q'ty/Reel
06P	24	11.50	/	3,600
08P				3,600
09P				3,600
10P				3,600
12P				3,600
13P				3,600
16P				3,600
17P	3,600			
26P	32	14.20	28.40	3,600
27P				3,600
30P				3,600
48P				3,600
49P	44	20.20	40.40	3,600
50P				3,600
51P				3,600
53P	56	26.2	52.40	3,600
56P				3,600
57P				3,600
57P				3,600

				燦達電子工業股份有限公司 JOINT TECH ELECTRONIC IND. CO., LTD.	
		UNIT	SCALE	SHEET	
		mm	1 : 1	2 of 2	
		DRAWN BY		APPROVED BY	
		李志深		陳彥兆	
		2015.02.05		2015.02.05	
GENERAL TOLERANCE					
		X. X±0.25	ANGLE±		
		X. XX±0.15			
		X. XXX±0.05			
A0	NEW RELEASE	2015.02.05	李志深	DRAW NO. :	
REV.	DESCRIPTION	DATE	NAME	F0517WRC-S-XPNXXXXXXXXX	
				REV. A0	

0.50mm PITCH FFC/FPC
CONNECTOR, 90° SMT TYPE