

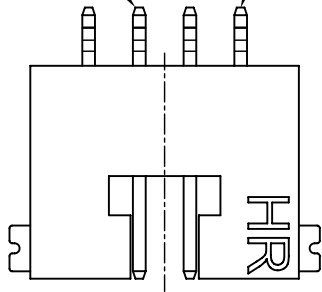

PIN 0.500 SQ Circuit 1

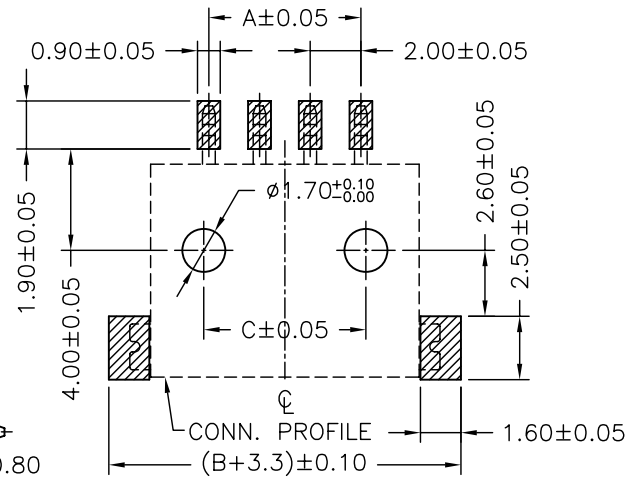

(TOP VIEW)

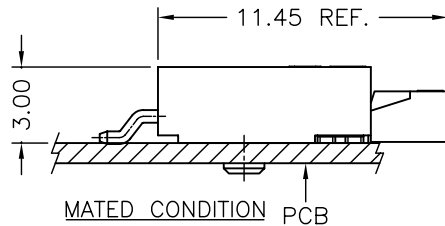
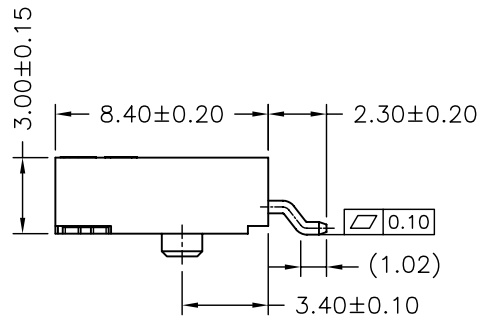
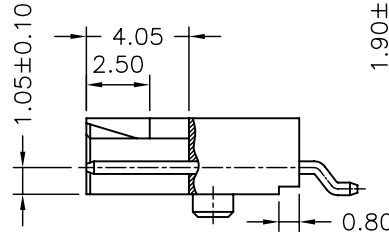
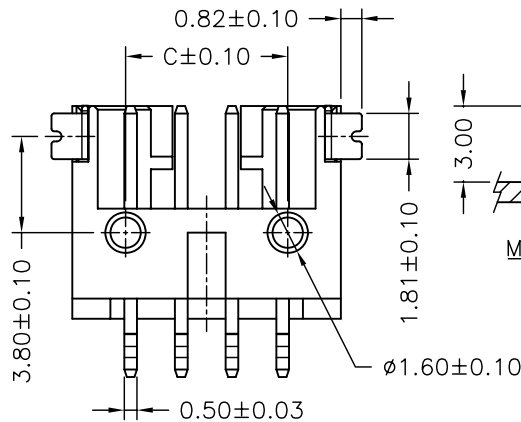
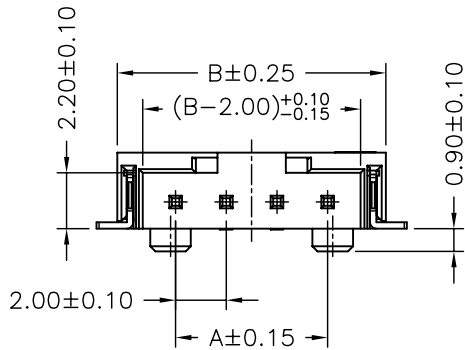

PCB LAYOUT (TOP VIEW)

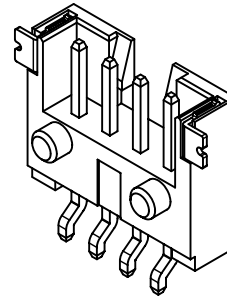

P/N LEGEND

A2014 WR-SF1-XP N L N G1 G 00 R  
① ② ③ ④ ⑤ ⑥ ⑦ ⑧ ⑨ ⑩ ⑪

- ① Series No.
- ② Connector type: WR=Right angle
- ③ Mounting type: SF1=SMT with boss
- ④ No. of circuits
- ⑤ N=Halogen Free
- ⑥ Material: L=LCP
- ⑦ Color: N=Natural(Beige)
- ⑧ Plating code for contacts:  
T1=Matte Tin-plated; G1=Gold-flash
- ⑨ Plating code for solder tabs:  
T=Matte Tin-plated; G=Gold-flash
- ⑩ Option code: 00=Standard
- ⑪ Packing code: R=Tape & Reel(Without Cap or Mylar)

SPECIFICATIONS

Current Rating: 3A AC,DC  
Voltage Rating: 250V AC,DC  
Temperature Range: -25°C ~ +85°C  
Contact Resistance: 30mΩ Max.  
Insulation Resistance: 1000MΩ Min.  
Withstanding Voltage: 500V AC/minute  
Pin Material: Brass/Gold-flash  
Material: LCP,UL94V-0  
Color: Natural(Beige)

Circuit No.	Dimensions		
	A	B	C
04P	6.00	10.60	6.40
05P	8.00	12.60	8.40
06P	10.00	14.60	10.40
08P	14.00	18.60	14.40



燦達電子工業股份有限公司  
JOINT TECH ELECTRONIC IND. CO., LTD.

UNIT: mm SCALE: 1:1 SHEET: 1 of 2

DRAWN BY: 周傑亮  
2012.03.20  
APPROVED BY: 董正一  
2012.03.20

GENERAL TOLERANCE

A1: X.X±0.25  
A0: X.XX±0.15  
REV.: X.XXX±0.05

TITLE:  
2.00mm PITCH  
90° WAFER-SMT TYPE  
DRAW NO.: A2014WR-SF1-XPXXXXXXX REV. A1

REV.	DESCRIPTION	DATE	NAME
A1	EN1403100003	2014.02.28	周傑亮
A0	NEW RELEASE	2012.03.20	周傑亮



04~05 Contacts

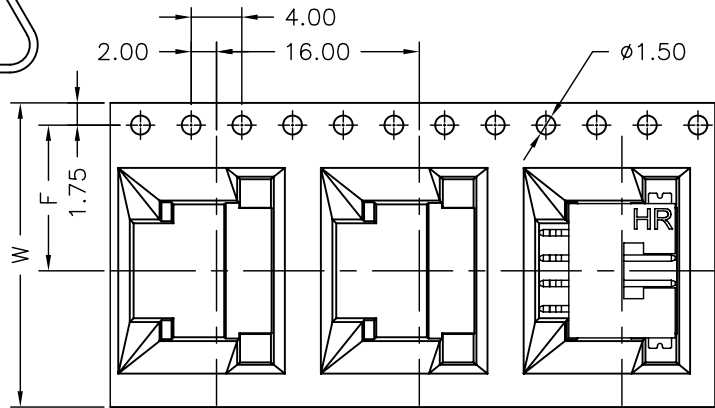

Unreeling direction →

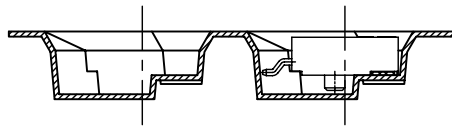

06~08 Contacts

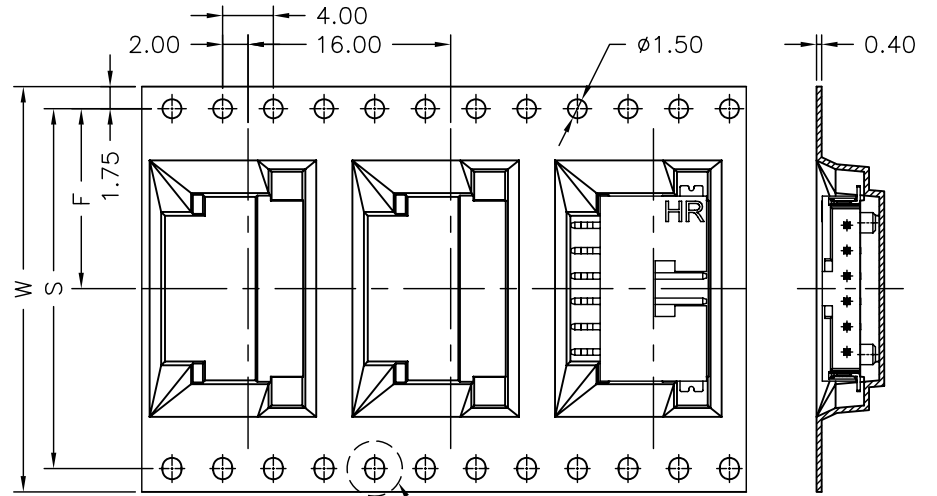

Unreeling direction →

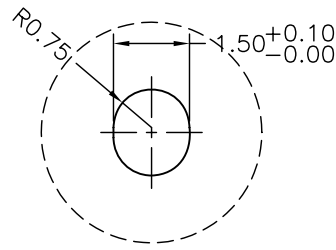
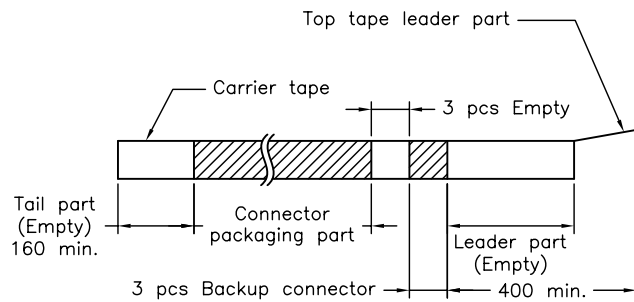

DETAIL "A"  
SCALE 4:1

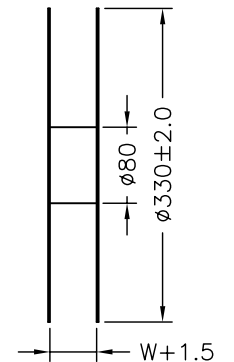
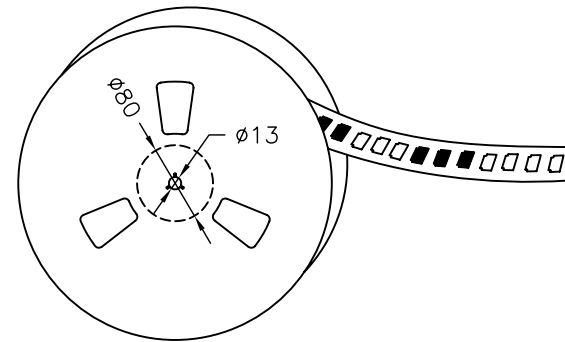

NOTE:

Material: Transparent  
Anti-static Polystyrene.

Number of Contacts	W±0.3	F±0.1	S±0.1	Q'ty/Reel
04P	24	11.50	/	800
05P	24	11.50		800
06P	32	14.20	28.40	800
08P	44	20.20	40.40	800

				燦達電子工業股份有限公司 JOINT TECH ELECTRONIC IND. CO., LTD.	
UNIT	SCALE	SHEET	TITLE:		
mm	1 : 1	2 of 2	2.00mm PITCH 90° WAFER-SMT TYPE, TAPING SPEC.		
DRAWN BY 周傑亮		APPROVED BY 董正一			
2012.03.20		2012.03.20	DRAW NO. : A2014WR-SF1-XPNXXXXXXXXX		
GENERAL TOLERANCE			REV. A1		
A1	EN1403100003	2014.02.28	周傑亮	X.X±0.25	ANGLE±
A0	NEW RELEASE	2012.03.20	周傑亮	X.XX±0.15	
REV.	DESCRIPTION	DATE	NAME	X.XXX±0.05	